

Beginner Solution Booklet

Round 1

B1

B2

B3

Sudoku

1	2	3	4	5	6
5	4	6	2	3	1
2	6	5	1	4	3
4	3	1	6	2	5
6	5	2	3	1	4
3	1	4	5	6	2

djmathman

9	6	1	3	2	4	8	7	5
3	7	8	6	5	9	2	4	1
2	5	4	1	7	8	9	3	6
8	1	3	9	6	2	7	5	4
7	4	2	5	1	3	6	8	9
6	9	5	4	8	7	1	2	3
4	3	7	8	9	6	5	1	2
5	8	6	2	3	1	4	9	7
1	2	9	7	4	5	3	6	8

djmathman

7	5	3	4	1	8	2	9	6
9	6	8	7	2	5	4	3	1
1	2	4	6	3	9	8	7	5
8	7	1	5	4	3	6	2	9
2	3	5	9	8	6	1	4	7
6	4	9	2	7	1	3	5	8
5	1	6	3	9	2	7	8	4
3	9	7	8	6	4	5	1	2
4	8	2	1	5	7	9	6	3

djmathman

Scrabble

			T				
	B	O	W	L			
	L	O		L	A	W	
	U		A			O	
	S	T	O	L	E		R
	H			L			D
			H	O	L	D	S
			Y				

djmathman

B	I	B	I	M	B	A	P
E	A			U		R	
B	R			M		O	
O	B	A	O	B	A	B	
P	A			L		A	
	P	R	O	V	E	R	B
		I			B	L	
	B	A	T	T	E	R	Y
		N		E			

ft029

			N							
		S	U	D	O	K	U			
T		M							S	
O		B							C	
M	I	N	E	S	W	E	E	P	E	R
T		R							A	
O		L							B	
M	H	I	D	A	T	O			B	
			N						L	
			K						E	

jkittykitkat

Numberlink

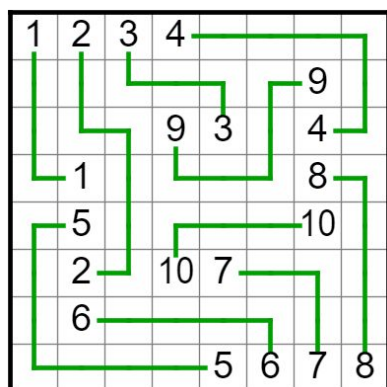

djmathman

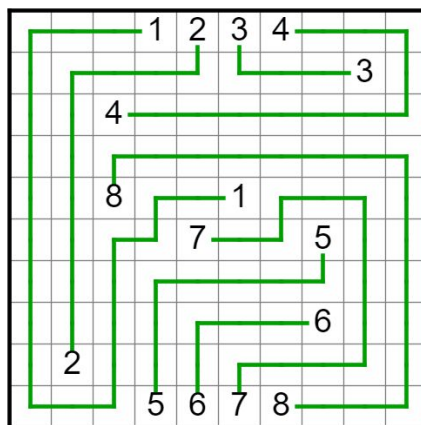

djmathman

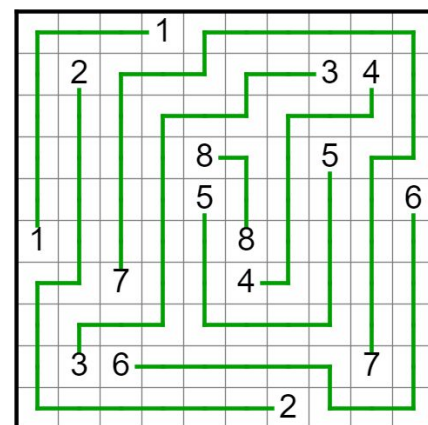

djmathman

Round 1

B1

B2

B3

Battleships

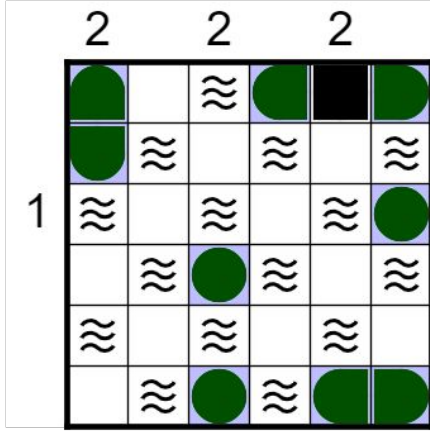

rever

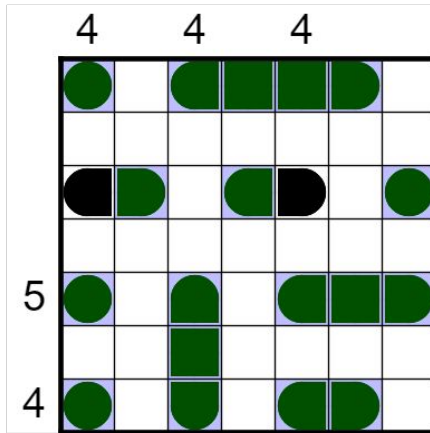

rever

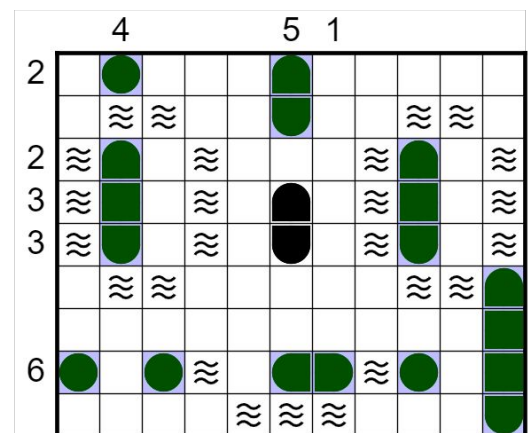

ft029

Wordle Bank



ft029

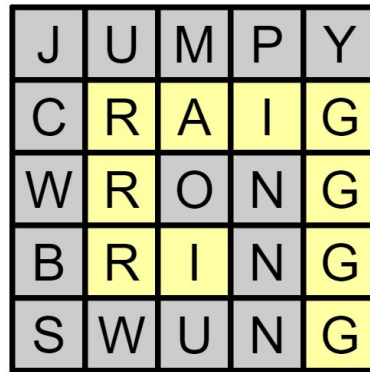

ft029

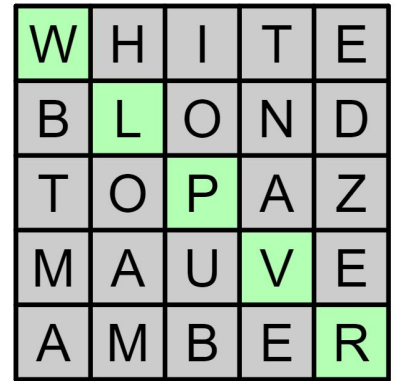

djmathman

Round 2

B1

B2

B3

Square Jam

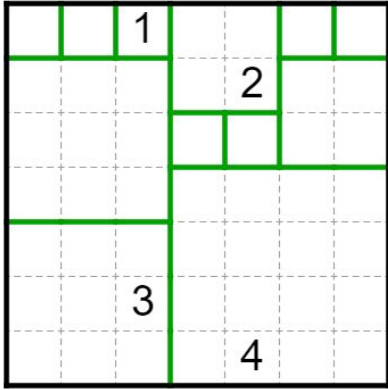

jkittykitkat

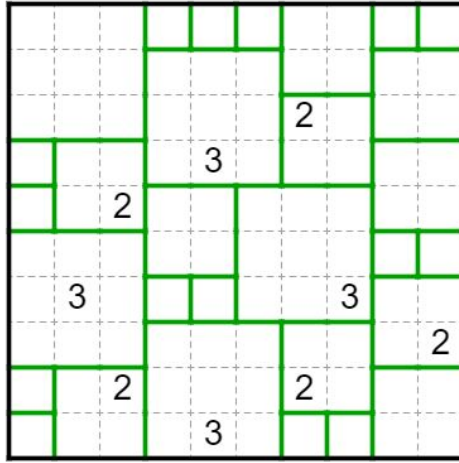

jkittykitkat

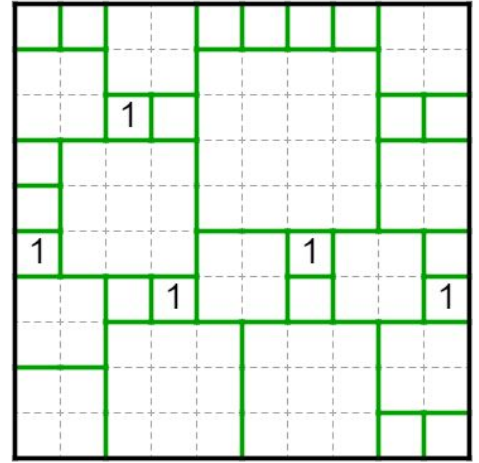

jkittykitkat

Aquapelago

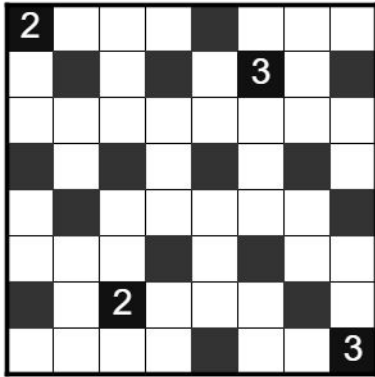

djmathman

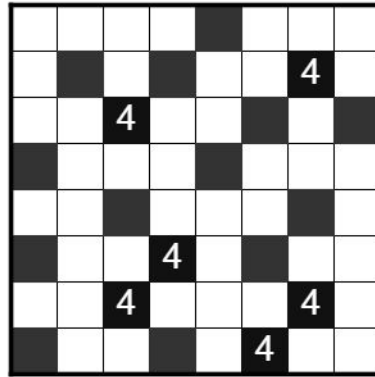

rever

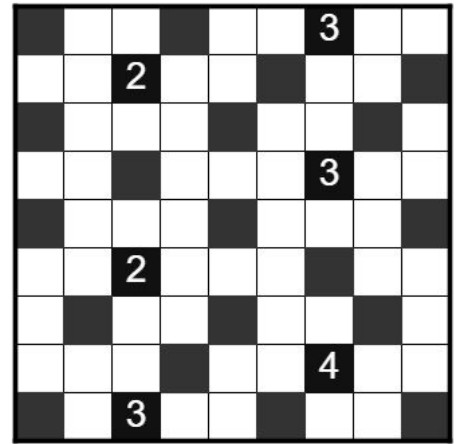

djmathman

Castle Wall

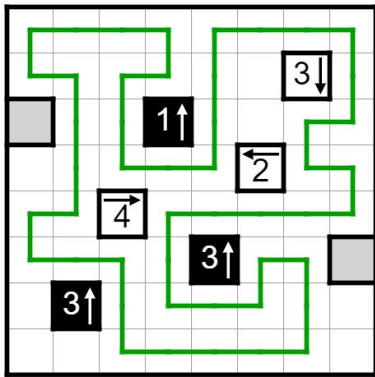

rever

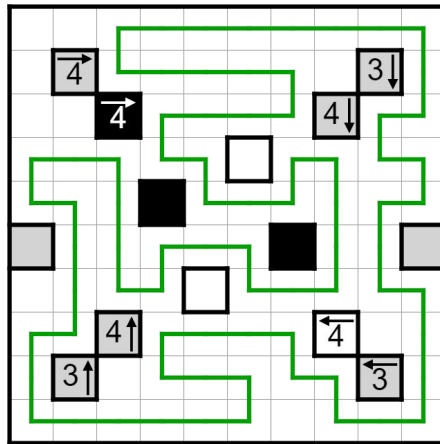

rever

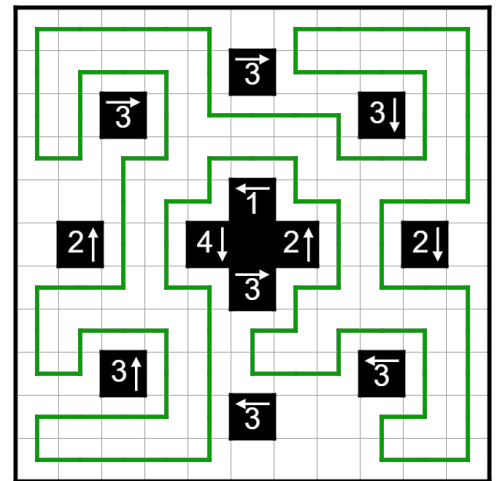

rever

Isowatari

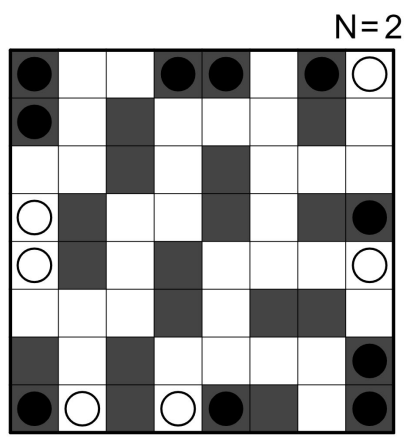

N=2

djmathman

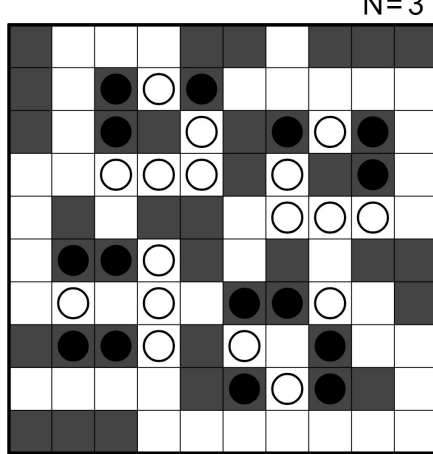

N=3

djmathman

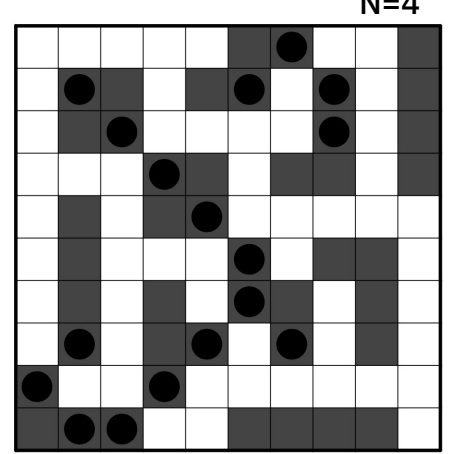

N=4

djmathman

Pentominous (Borders)

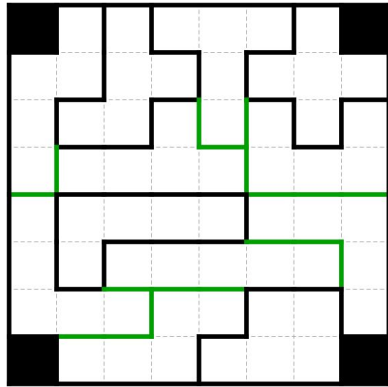

djmathman

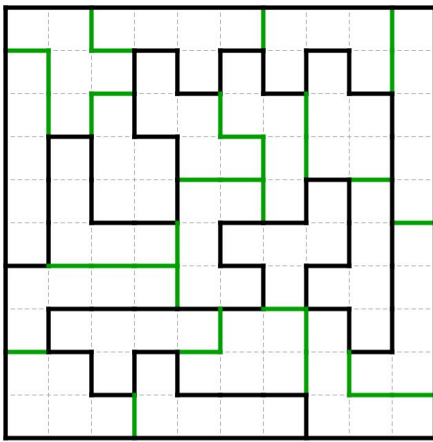

djmathman

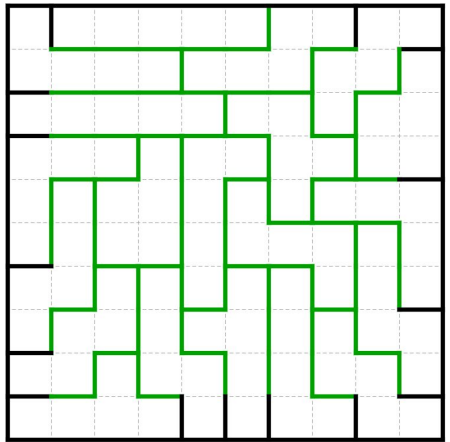

djmathman

Round 3

B1

B2

B3

Star Battle

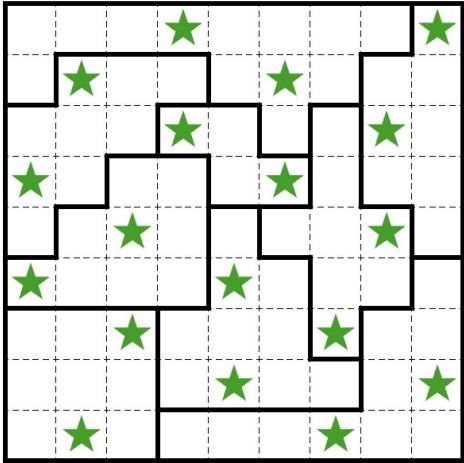

ft029

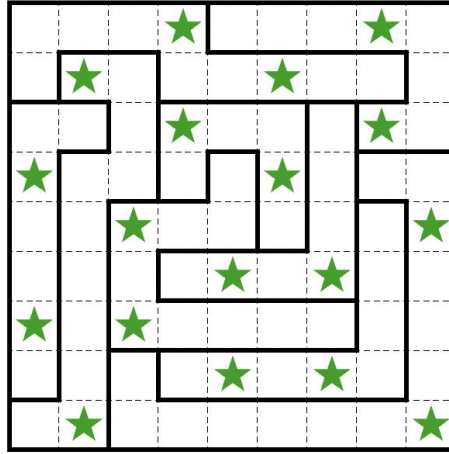

ft029

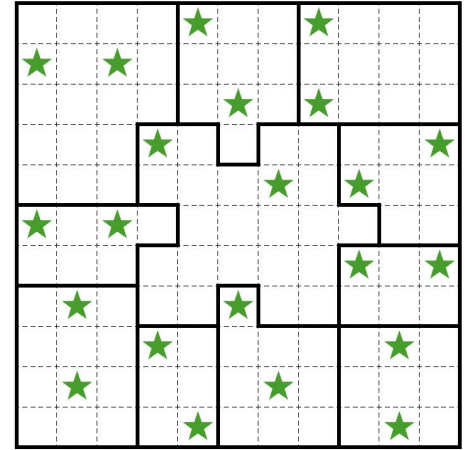

rever

Masyu

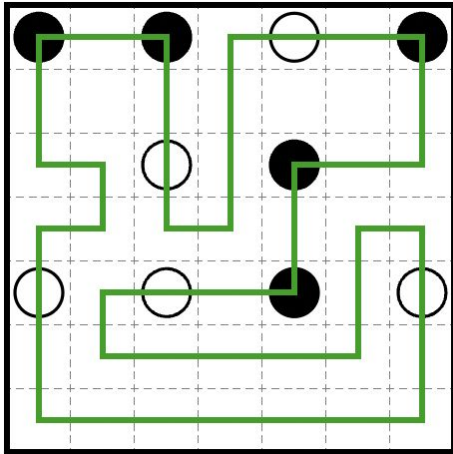

rever

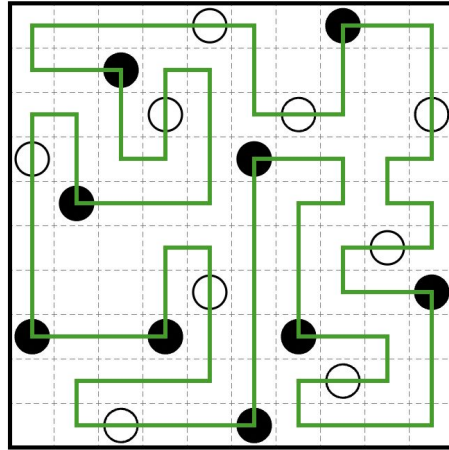

djmathman

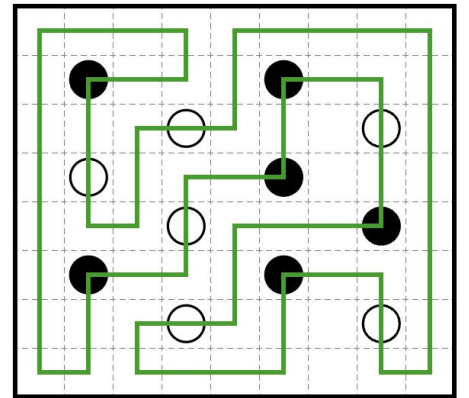

jkittykitkat

LITS

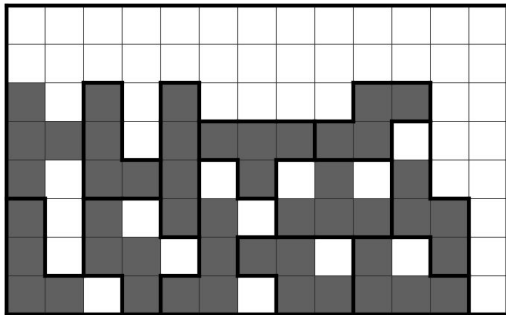

rever

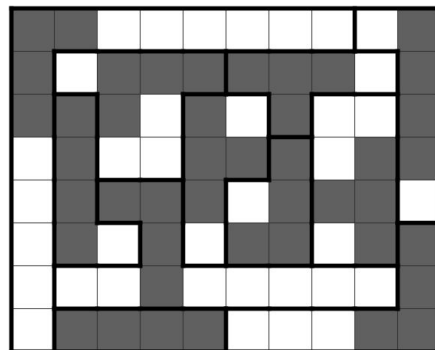

rever

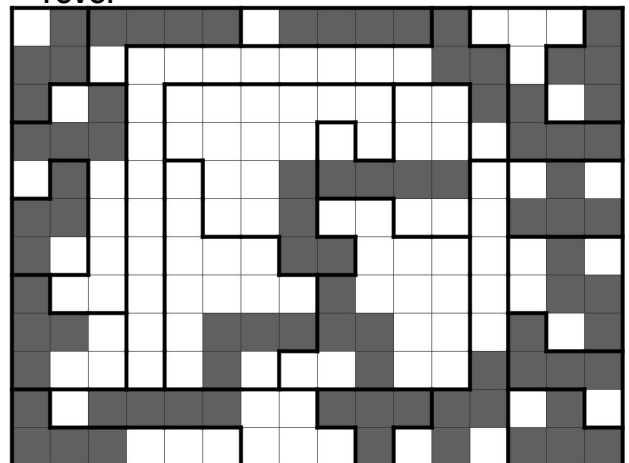

rever

Round 3

B1

B2

B3

Double Choco

				5					
					6				
		7							
	2	3							
			9		9				
				9					

ft029

2				5		3			
5									
									2
2		4							3

djmathman

	3						3		
			3						
					1				
	3								
			2						
	2							3	

jkittykitkat

Kakuro

				5	2	8			
	9	1		7	9				
9	3	2	1		1				
5	5		7	9	4	2			
7	4	3		7	3				
8	2	1	5						

djmathman

	1	2				1	9			
	3	1	2			1	6	8	9	
		4	1	3	2		2	4	1	
			4	9	7	8		2	7	
			1	3	2		6	8	1	
			3	2		7	8	9	5	
			1	4	2		6	7	9	8
			7	6	8	9		7	9	8
			7	9						

djmathman

	4	8		1	6	4	3	2	
	2	4	9		3	8	4	1	
	1		7	6	2		6	9	
	3	9		9	1	4	2		
	6	1	8		4	8	1	2	
		2	1	7	5		7	5	
			7	9			1	5	9

mstang

Round 4

B1

B2

B3

Shakashaka

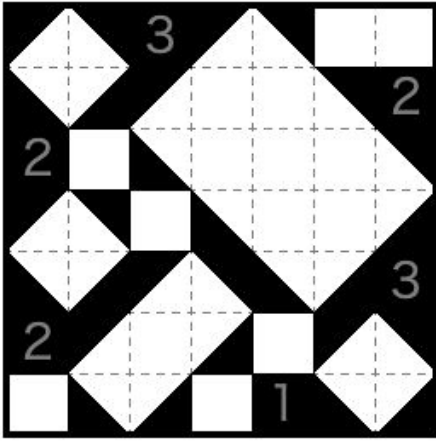

ft029

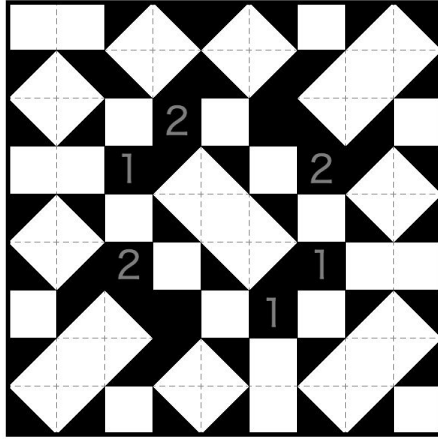

ft029

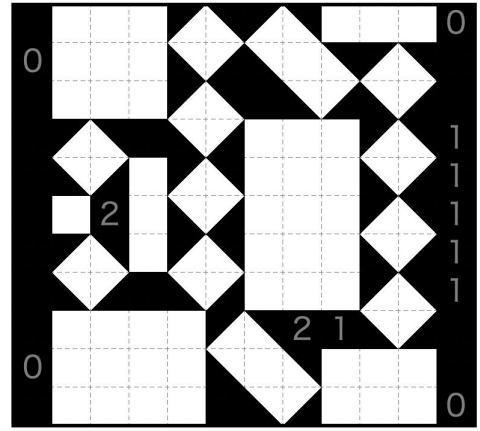

ft029

Japanese Sums

5	4			
1		5	3	
	2		4	3
3		4	2	
4				5

djmathman

1		2	4	
5	3	4	1	2
	4		3	
3	5	1	2	4
4	2		5	3

djmathman

4	3		5	6		
	5	1	2	3		
3	6	4			2	5
	4	3		2	5	1
	2		3	5	1	
		6	1			
		5				4

djmathman

Barns

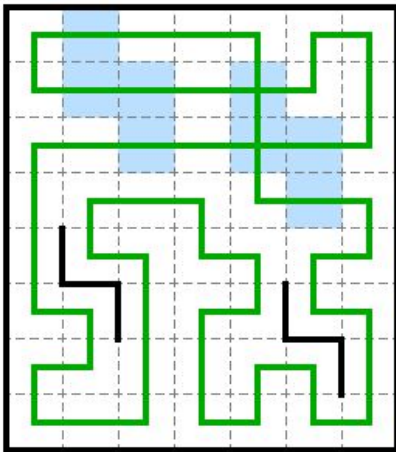

jkittykitkat

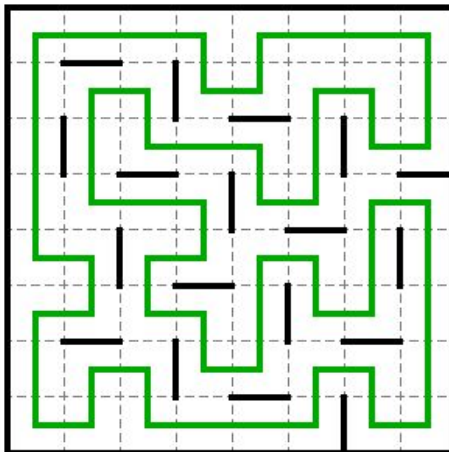

jkittykitkat

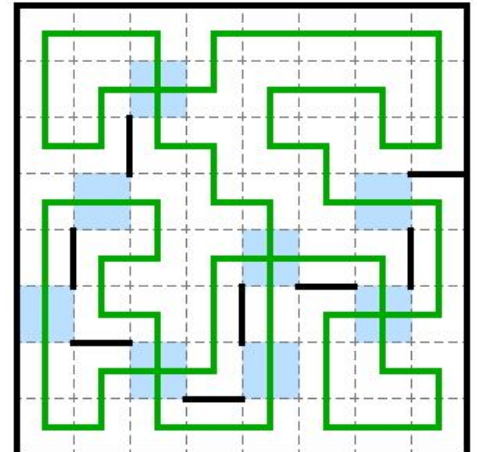

jkittykitkat

Round 4

B1

B2

B3

Fillomino (Blokus)

3	5	5	5	5	2	5
3	3	2	2	5	2	5
2	2	3	3	2	5	5
3	3	4	3	2	7	5
2	3	4	2	7	7	7
2	4	4	2	7	7	7
1	2	2	4	4	4	4

mstang

4	4	4	7	7	7	7
1	4	3	7	3	3	7
4	1	3	3	5	3	7
4	4	1	5	5	5	3
4	1	2	1	5	3	3
1	4	2	3	3	5	5
4	4	4	3	5	5	5

mstang

3	3	3	1	9	9	9	9
7	7	1	6	1	9	1	9
7	1	6	6	6	1	9	9
7	7	1	6	6	5	1	9
10	7	7	4	5	5	5	1
10	10	1	4	4	5	1	2
10	10	10	1	4	1	4	2
10	10	10	10	1	4	4	4

mstang

Mintonette

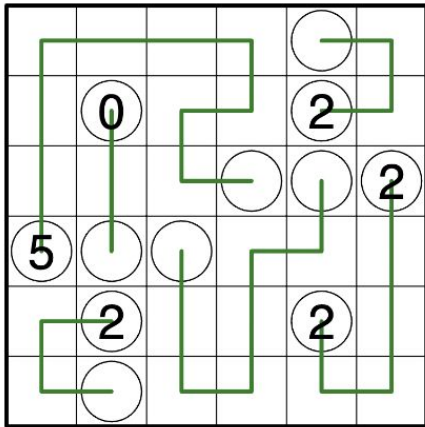

rever

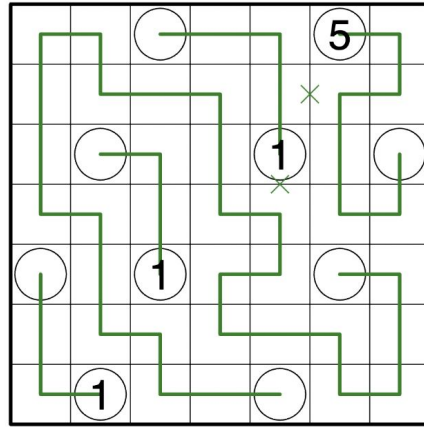

rever

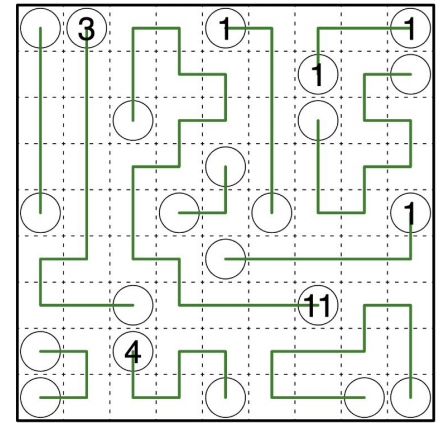

rever