

Advanced Solution Booklet

Round 1

A1

A2

A3

Sudoku

1	2	3	4	5	6
5	4	6	2	3	1
2	6	5	1	4	3
4	3	1	6	2	5
6	5	2	3	1	4
3	1	4	5	6	2

djmathman

7	5	3	4	1	8	2	9	6
9	6	8	7	2	5	4	3	1
1	2	4	6	3	9	8	7	5
8	7	1	5	4	3	6	2	9
2	3	5	9	8	6	1	4	7
6	4	9	2	7	1	3	5	8
5	1	6	3	9	2	7	8	4
3	9	7	8	6	4	5	1	2
4	8	2	1	5	7	9	6	3

djmathman

7	5	4	8	3	2	1	9	6
6	9	2	5	1	7	8	3	4
8	3	1	9	6	4	7	5	2
3	1	9	7	8	6	2	4	5
2	8	5	4	9	1	3	6	7
4	7	6	2	5	3	9	8	1
9	4	7	3	2	5	6	1	8
1	2	8	6	4	9	5	7	3
5	6	3	1	7	8	4	2	9

djmathman

Scrabble

			T					
	B	O	W	L				
	L		O		L	A	W	
	U			A			O	
	S	T	O	L	E		R	
	H			L			D	
			H	O	L	D	S	
			Y					

djmathman

			N							
		S	U	D	O	K	U			
T		M							S	
O		B							C	
M	I	N	E	S	W	E	E	P	E	R
T		R								A
O		L								B
M		H	I	D	A	T	O			B
			N							L
			K							E

jkittykitkat

		W			e	x	p	(i	π)	=	-	1	
	f	=	1	/	T				r			/			
		∫							²	Δ			2		
∫	∫	F	.	n	d	S					S		m		
∫		.					=			p	=	m	v		
∫	u	d	v	=	u	v	-	∫	v	d	u	Δ		²	
∇		s						r	e		Q				
.					∫	t	²	d	t	=	1	/	3	t	³
F	=	m	a					d	(T				
d					i	m		A			E				
V					²			F	-	E	+	V	=	2	
		Σ	1	/	n	=	∞		λ				m		
					-			l					c		
			φ	=	(1	+	√	5)	/	2		²	

Round 1

A1

A2

A3

Numberlink

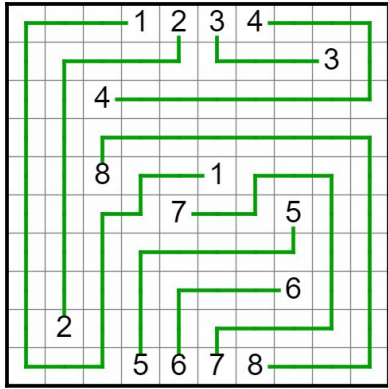

djmathman

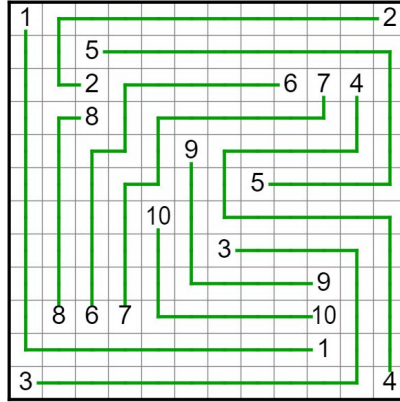

djmathman

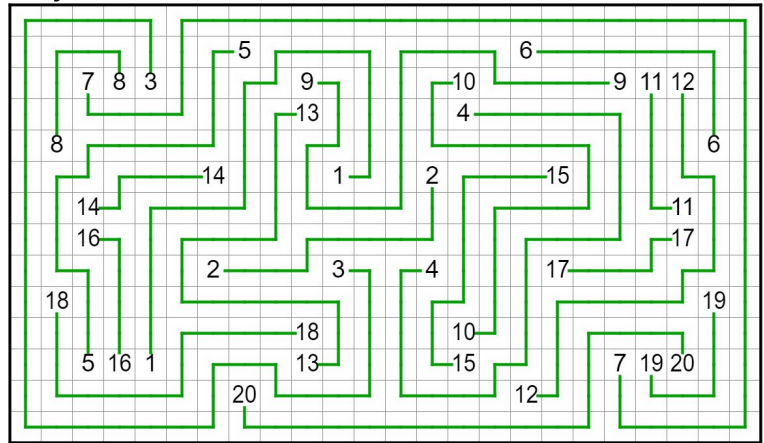

djmathman

Battleships

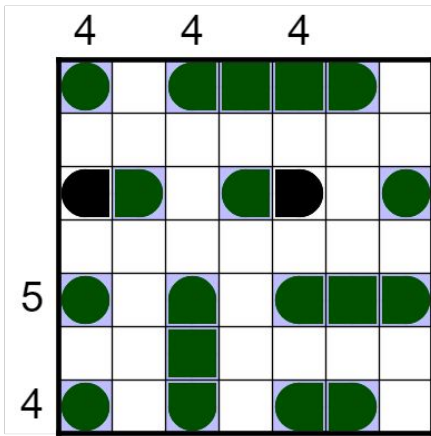

rever

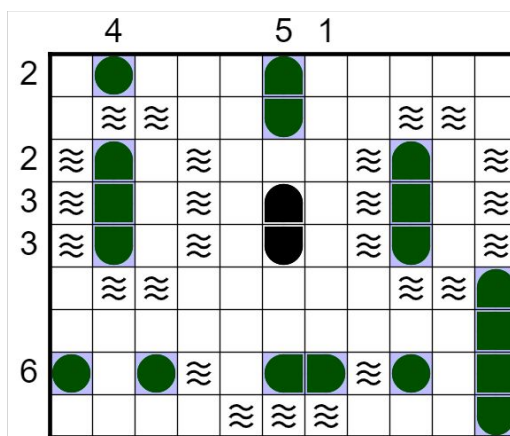

ft029

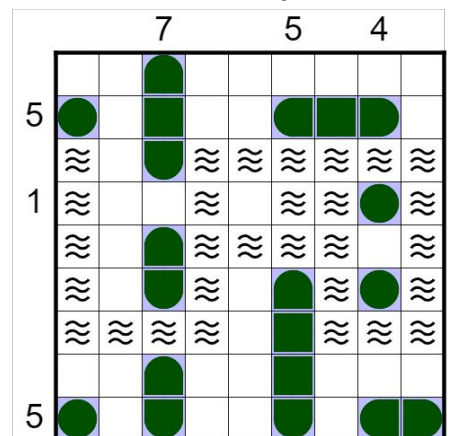

rever

Wordle Bank

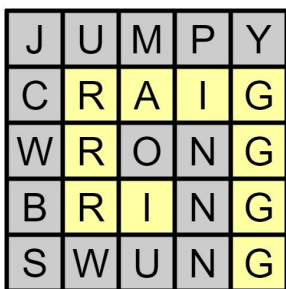

ft029

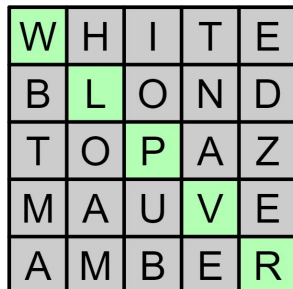

djmathman

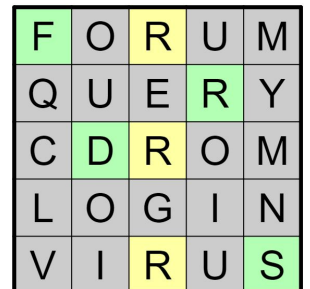
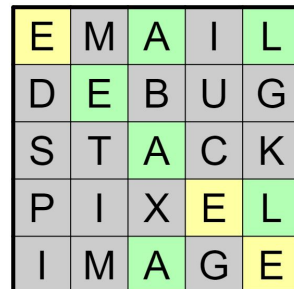

djmathman

Round 2

A1

A2

A3

Square Jam

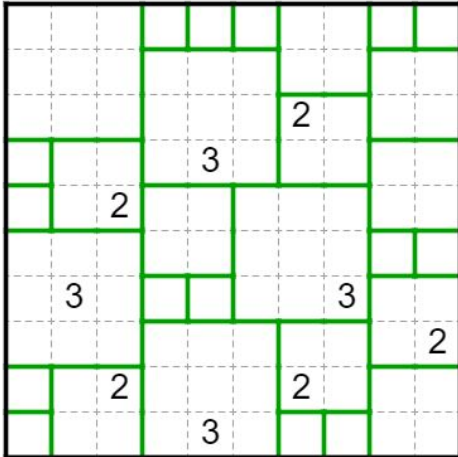

jkittykitkat

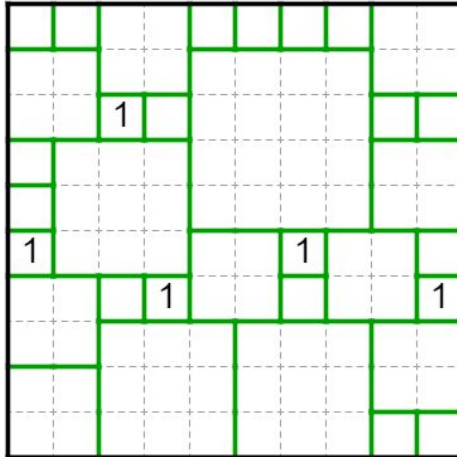

jkittykitkat

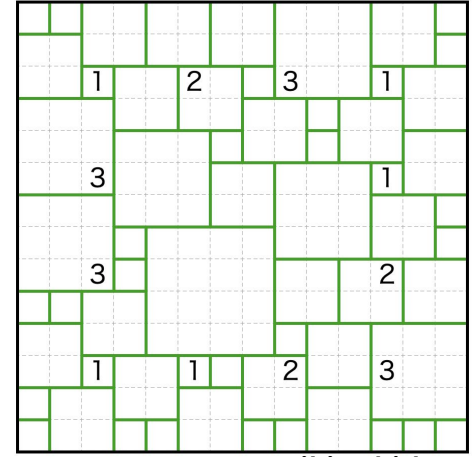

jkittykitkat

Aquapelago

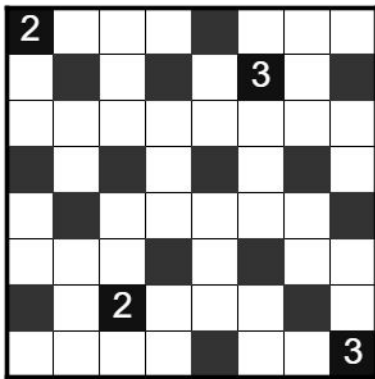

djmathman

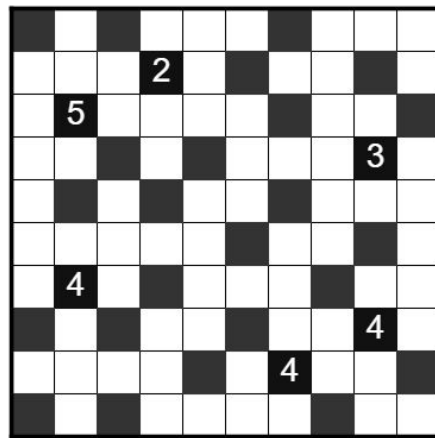

djmathman

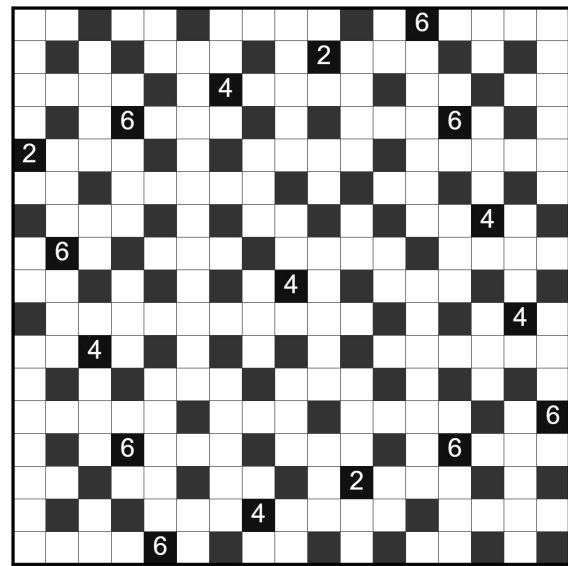

djmathman

Castle Wall

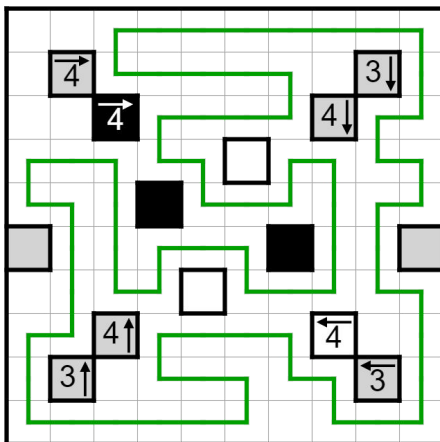

rever

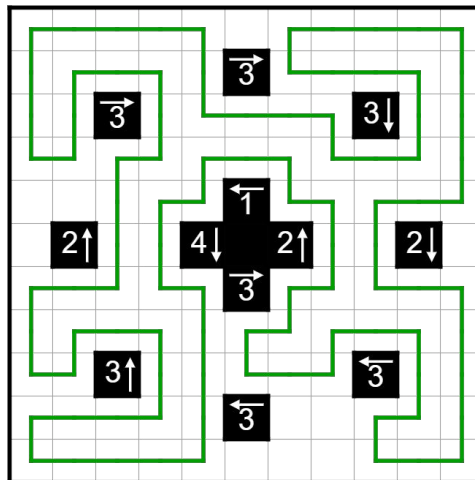

rever

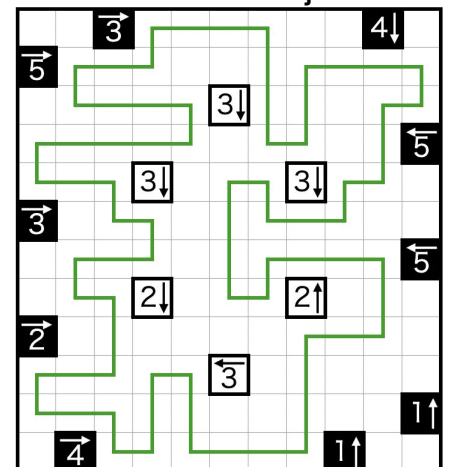

mstang

Round 2

A1

A2

A3

Isowatari

N=3

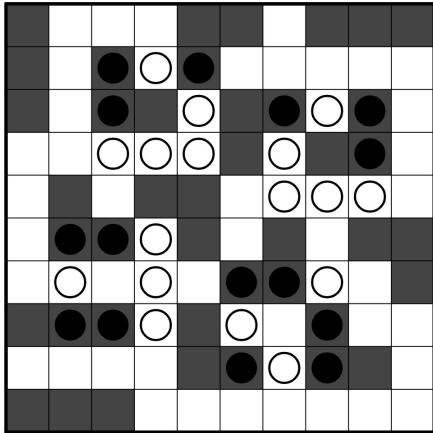

djmathman

N=4

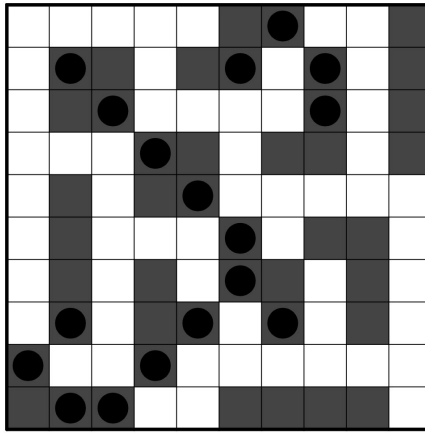

ft029

N=5

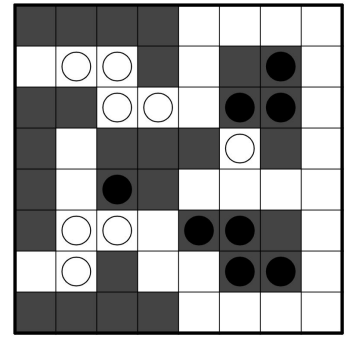

jkittykitkat

Pentominous (Borders)

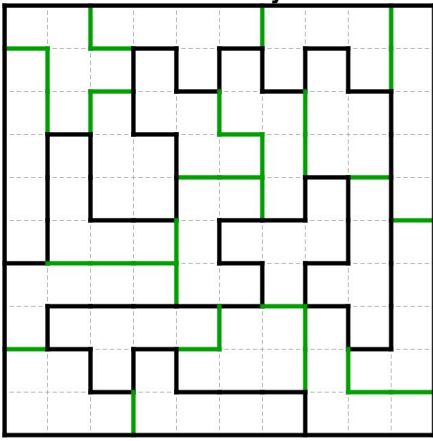

djmathman

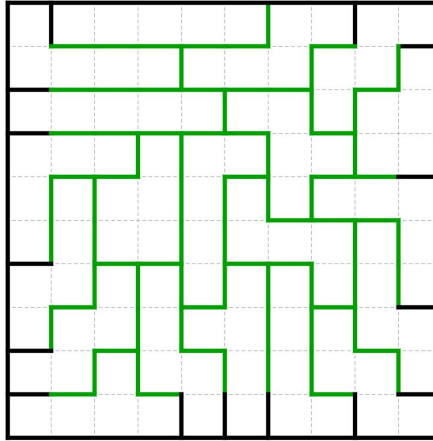

djmathman

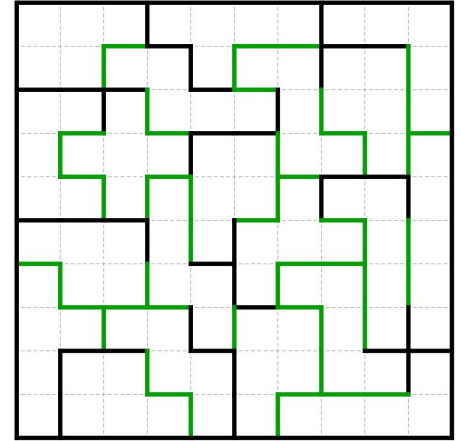

djmathman

Round 3

A1

A2

A3

Star Battle

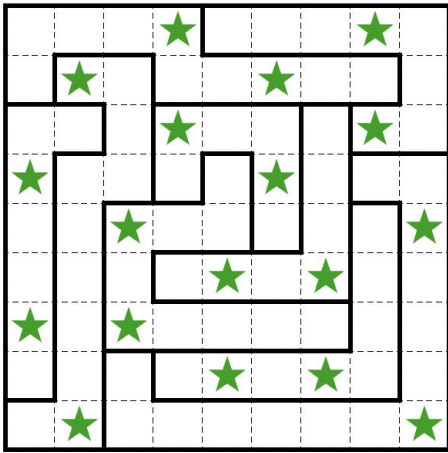

ft029

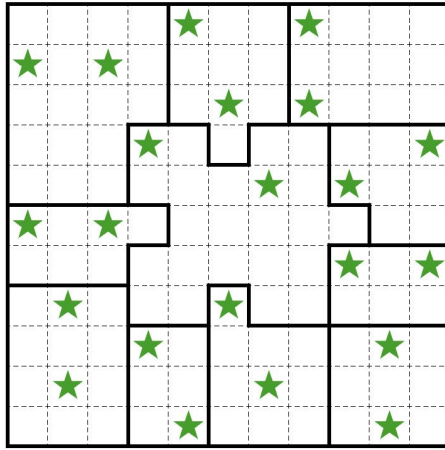

rever

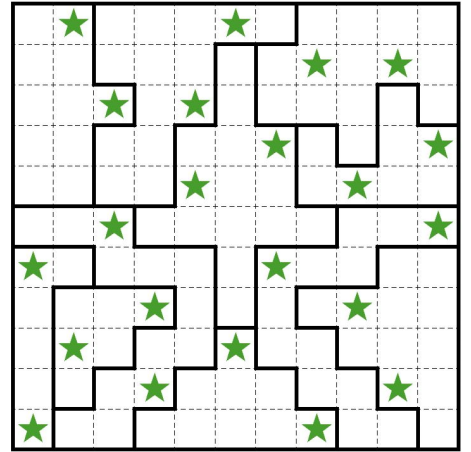

ft029

Masyu

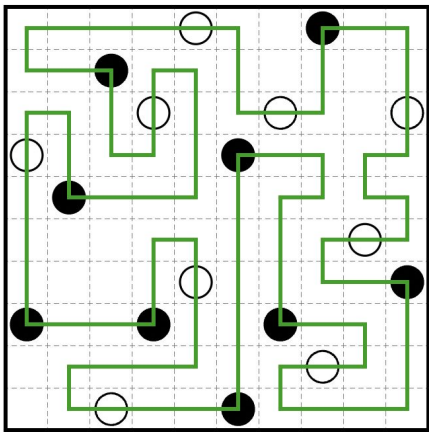

djmathman

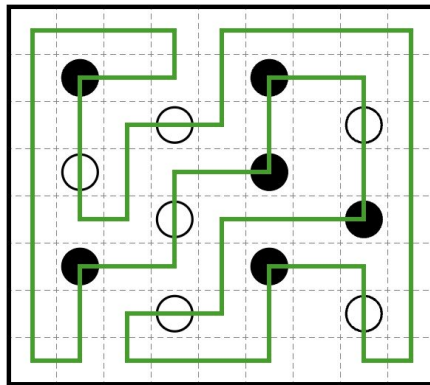

jkittykitkat

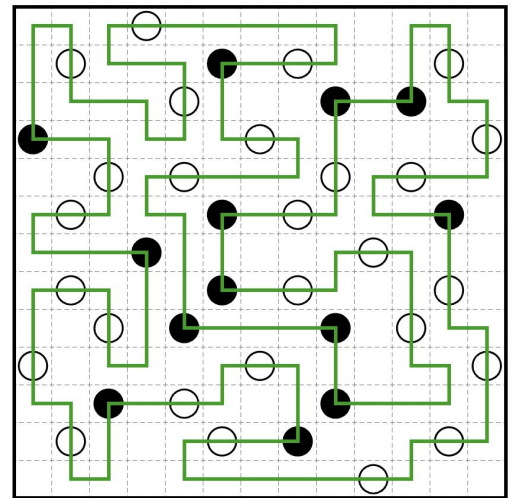

djmathman

LITS

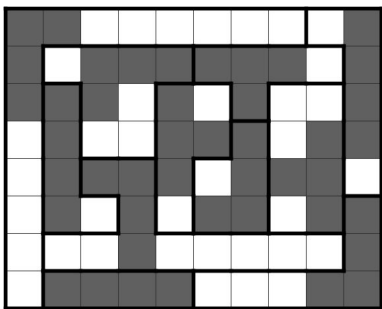

rever

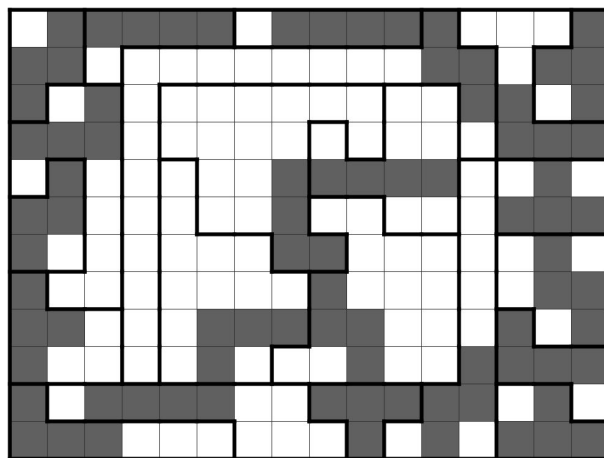

rever

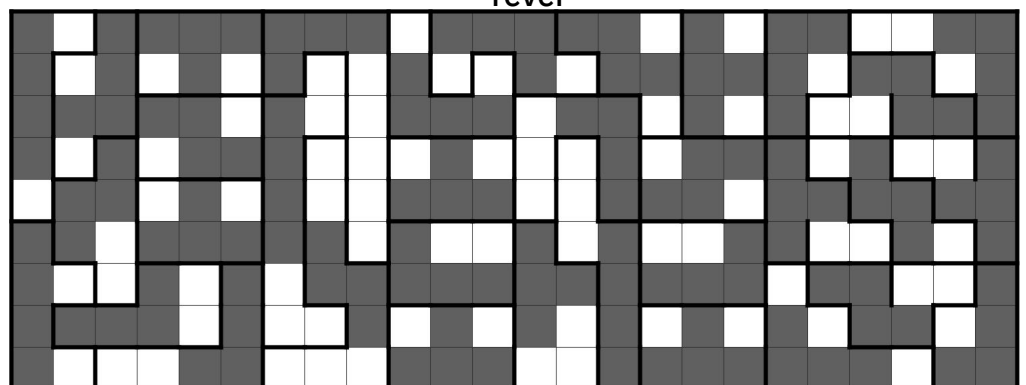

jkittykitkat

Round 3

A1

A2

A3

Double Choco

2				5		3
5						
						2
2	4					3

djmatham

	3				3	
		3				
			1			
	3					
		2				
2					3	

jkittykitkat

3		4				
	2			4	2	
						3
	3		4		3	4
4		2				2
					3	4

jkittykitkat

Kakuro

4	7			7	19				
3	1	2	10		1	9	16		
6	3	1	2	21	1	6	8	9	8
	4	1	3	2	30	2	4	1	
	4	9	7	8	9	2	7		
	1	3	2	15	6	8	1		
5	3	2	15	7	8	9	5	18	
7	1	4	2	30	6	7	9	8	11
	7	6	8	9	24	7	9	8	
	7	9			4	1	3		

djmatham

16	12			16		12		12	
12	4	8	16	1	6	4	3	2	
15	2	4	9	15	3	8	4	1	
	1	7	6	2	15	6	9		
12	3	9	16	9	1	4	2	16	
15	6	1	8	15	4	8	1	2	
	2	1	7	5	12	7	5		
	7	9		15	1	5	9		

mstang

35		7	18	28	4	12		16	10						
43	8	9	4	5	6	1	3	7	23	8	6	9	16		
17	8	9	35	2	6	7	3	9	8	11	3	1	5	2	
16	9	7	10	1	4	5		36	9	8	5	3	7	4	
12	7	5	10	17	3	2	1	10	6	4		7	4	3	
21	2	3	5	6	1	4	5	14	9	2	3		3	2	1
	1	2	3	4	16	3	1	6	4	2		14	8	6	
	10	1	2	7	39	2	4	8	5	1	9	7	3		

mstang

Shakashaka

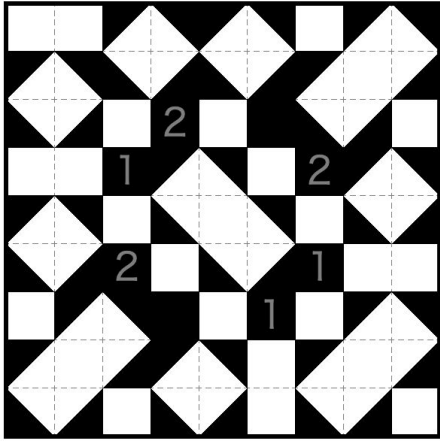

ft029

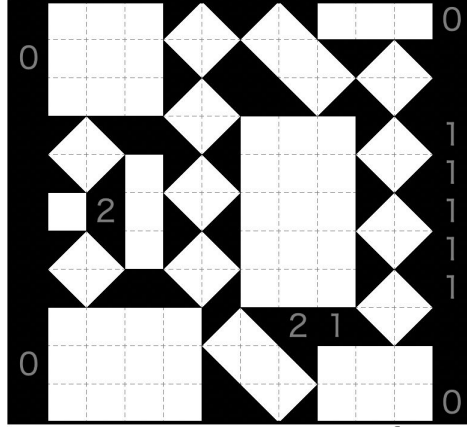

ft029

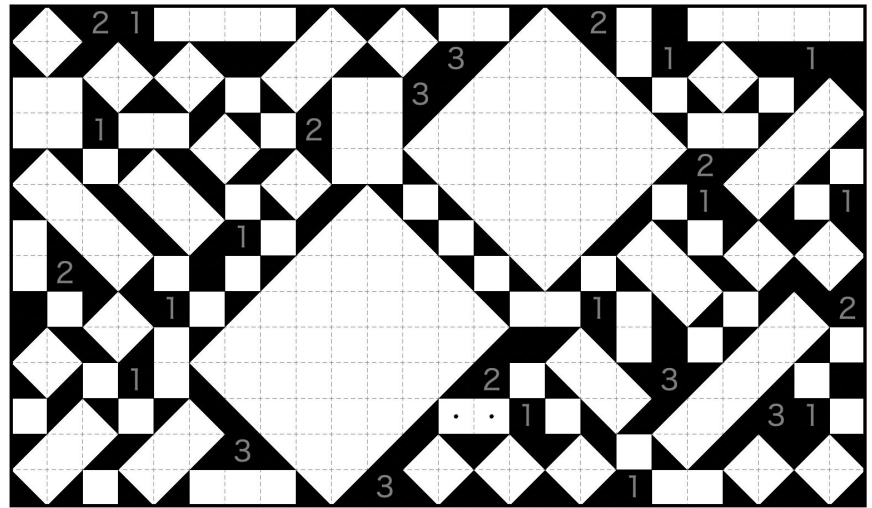

ft029

Japanese Sums

1		2	4	
5	3	4	1	2
	4		3	
3	5	1	2	4
4	2		5	3

djmathman

4	3		5	6		
	5	1	2	3		
3	6	4			2	5
	4	3		2	5	1
	2		3	5	1	
		6	1			
		5				4

djmathman

	4		5	6			3
3	5		2	7		6	4
4	7	3		1		2	6
2		6			4	5	
		1	7		3		5
6		2			5	7	1
1	6			4		3	7
5		7		2	6	1	

djmathman

Round 4

A1

A2

A3

Barns

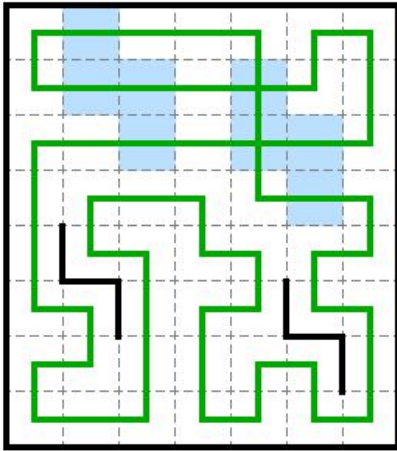

jkittykitkat

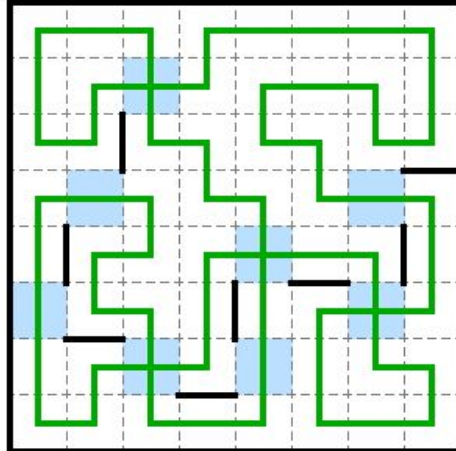

jkittykitkat

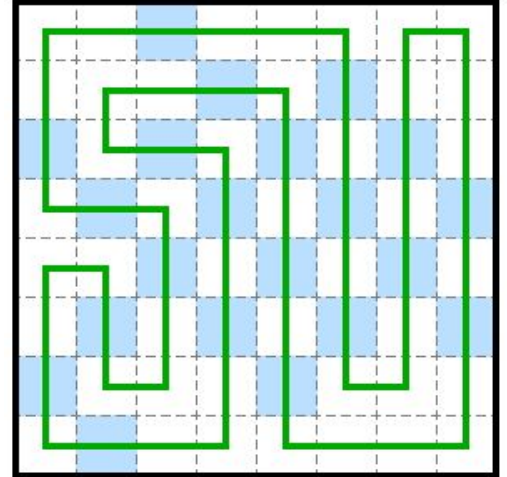

jkittykitkat

Fillomino (Blokus)

3	5	5	5	5	2	5
3	3	2	2	5	2	5
2	2	3	3	2	5	5
3	3	4	3	2	7	5
2	3	4	2	7	7	7
2	4	4	2	7	7	7
1	2	2	4	4	4	4

mstang

3	3	3	1	9	9	9	9
7	7	1	6	1	9	1	9
7	1	6	6	6	1	9	9
7	7	1	6	6	5	1	9
10	7	7	4	5	5	5	1
10	10	1	4	4	5	1	2
10	10	10	1	4	1	4	2
10	10	10	10	1	4	4	4

mstang

5	5	5	5	6	6	6	6	8	8
5	6	6	6	5	6	6	8	8	4
2	2	6	6	5	5	8	8	4	4
6	6	2	6	5	8	8	4	8	4
6	1	2	1	5	4	4	4	8	8
6	6	1	4	4	5	8	8	8	8
4	6	4	4	10	5	5	8	5	5
4	4	6	6	10	10	5	5	7	5
4	6	6	6	6	10	7	7	7	5
10	10	10	10	10	10	7	7	7	5

mstang

Mintonette

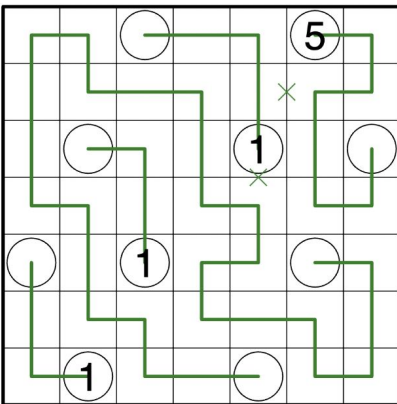

rever

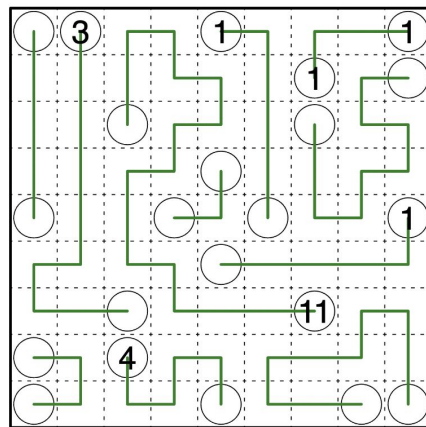

rever

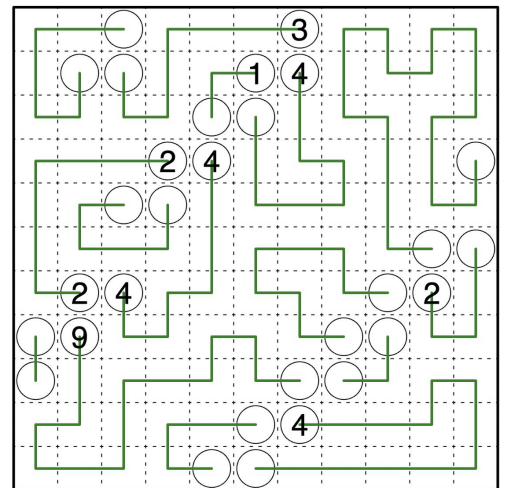

rever