

## Round 1: Pop Culture

### Sudoku

3 points

1	2	3	6	4	5
5	6	4	3	1	2
4	5	1	2	3	6
6	3	2	4	5	1
3	1	6	5	2	4
2	4	5	1	6	3

5 points

6	1	2	4	8	5	7	3	9
4	5	8	3	9	7	2	6	1
3	7	9	2	1	6	4	5	8
9	4	3	6	5	2	8	1	7
2	8	7	1	3	9	5	4	6
1	6	5	7	4	8	9	2	3
5	2	1	8	7	3	6	9	4
7	3	6	9	2	4	1	8	5
8	9	4	5	6	1	3	7	2

9 points

7	5	8	4	1	9	3	6	2
6	1	9	3	5	2	7	4	8
2	3	4	7	6	8	9	5	1
5	7	3	6	2	4	8	1	9
1	8	6	5	9	7	2	3	4
4	9	2	1	8	3	6	7	5
3	2	7	9	4	5	1	8	6
8	6	5	2	7	1	4	9	3
9	4	1	8	3	6	5	2	7

By dj Theme two blanks

By dj Theme cross

By dj Theme clones

### Numberlink

2 points

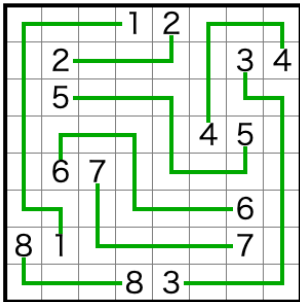

By dj Theme pairs

5 points

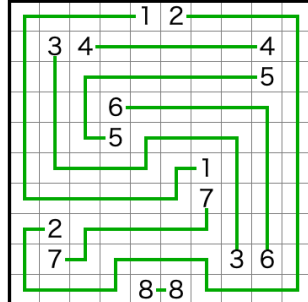

By dj Theme pairs

6 points

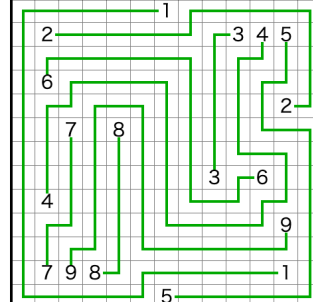

By dj Theme 9 clues

### Minesweeper

2 points

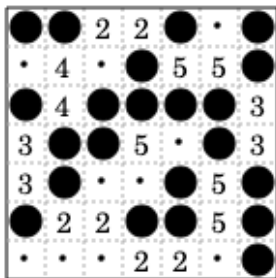

By dj Theme pairs

3 points

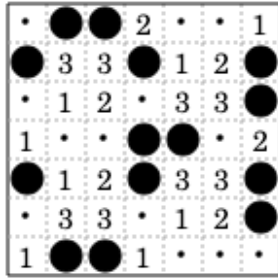

By jk Theme 2x2

7 points

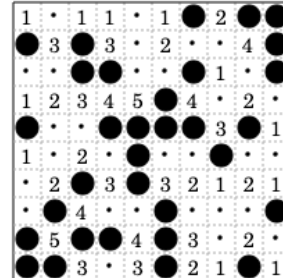

By ft Theme 12345

TomTom

3 points

3	4	6+	2	5
2	5+	5	4	4+
4x	2	4	5x	3
4	5	6x	1	2
5	1	2	3	4

6 points

20x	5	2	16+	6	15x	1	3
2	9+	3	6	1	5	11+	4
10+	1	6	2	3	4	5	
3	5	1	4	8+	6	2	
6	9+	4	3	12+	5	2	18x
4	1	5	2	3	6		

10 points

24	1	2	23	4	6	45	3	5
2	6	8	5	4	1	3		
7	3	1	2	5	4	4	6	
4	3	6	8	1	5	2		
20	5	4	3	2	13	6	1	
6	5	1	3	2	4			

By dj Theme antisymmetry By dj Theme Ls

By dj Theme four corners

Scrabble

3 points

			S					
F	R	I	D	A	Y	W		
			T			E		
T		T	H	U	R	S	D	A
U			R			N		
E			D			E		
S	U	N	D	A	Y	S		
D			Y			D		
A						A		
Y		M	O	N	D	A	Y	

5 points

		J						
C	R	A	B		K			
		C	L	A	N			
A	Q	U	I	F	E	R		
P	U	Z	Z	L	E			
P	I	Z	Z	A				
		L	I	A	M			
		T	R	E	S	T		
				D				

9 points

			B				C	
D	A	L	L	A	S		A	N
E		L	P	S	M		E	
N	D	E	T	R	O	I	T	B
V		I	R	L	A	R	E	D
E		M	T	O	I		R	
F	R	E	S	N	O	L	U	D
	Y	R	E	A	D	I	N	G
T		R	E	N	S	E		A
A	A		D		S	N	N	
C	H	I	C	A	G	O	A	T
O		U		W	P	W		
M		S	A	N	T	A	C	L
A		E		C	U	R		
				O	L	K		

By dj Theme days of the week By ft Theme crossword

By dj Theme us cities

Hidato

3 points

16	15	14	8	7	6
17	11	9	13	5	23
18	10	12	4	22	24
36	19	3	21	31	25
35	2	20	32	30	26
1	34	33	29	28	27

7 points

64	19	1	2	40	41	44	43
63	18	20	39	3	40	42	45
17	62	38	21	50	4	48	46
16	37	61	51	22	23	5	47
36	15	52	60	59	8	24	6
35	53	14	58	9	30	7	25
54	34	57	13	31	10	29	26
55	56	33	32	12	11	27	28

12 points

72	73	87	86	85	84	83	82	80	55	56	57
71	88	74	67	65	64	78	79	81	54	58	50
70	89	68	75	66	77	83	61	53	59	51	49
1	89	90	91	76	117	118	82	80	52	141	48
5	2	3	92	97	116	119	136	135	140	142	47
6	4	98	96	115	98	120	134	137	143	139	46
7	94	95	114	113	33	90	131	133	138	144	45
8	18	19	112	32	102	34	100	122	132	44	43
17	9	20	31	111	103	101	35	123	40	131	42
16	21	10	11	30	110	104	124	36	39	21	130
15	22	12	26	25	29	109	105	125	37	38	129
14	13	23	24	27	28	108	107	106	126	127	128

By dj, jk Theme line ends

By ft Theme outside clues

By dj Theme tilted square

Round 2: Numberless

Midloop

2 points

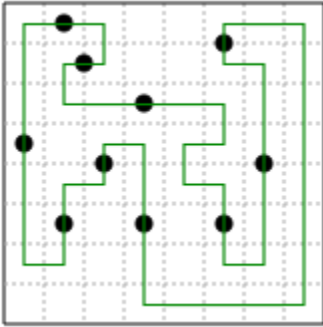

By dj Theme empty bottom

4 points

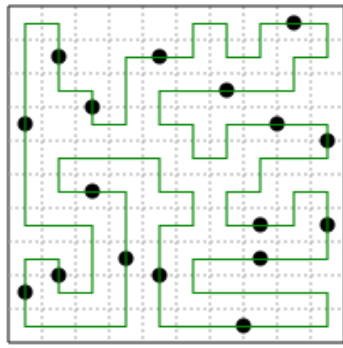

By dj Theme empty middle

6 points

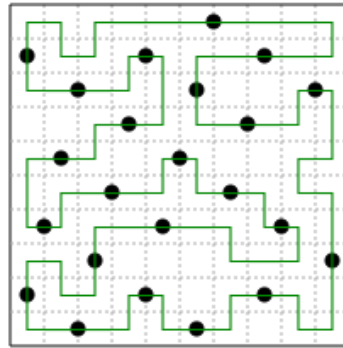

By dj Theme tessellation

Icebarn

4 points

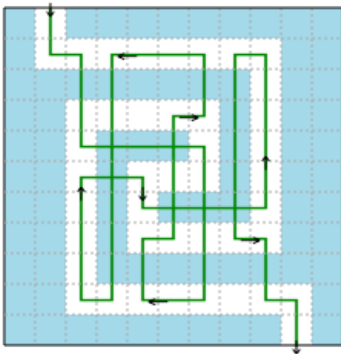

By ft Theme against the path

5 points

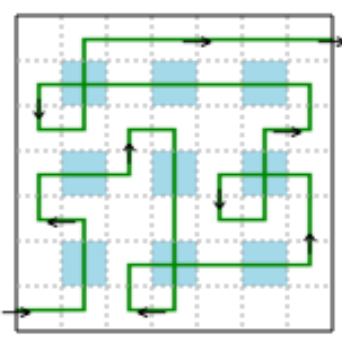

By jk Theme grid

6 points

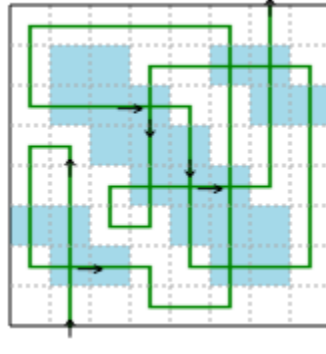

By dj Theme exit parity

Voxas

2 points

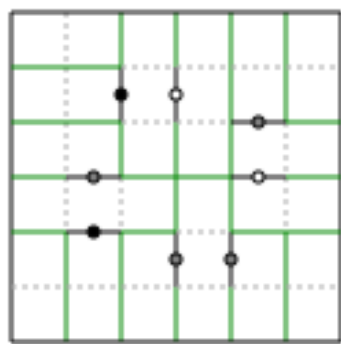

By jk Theme antisymmetry slits

7 points

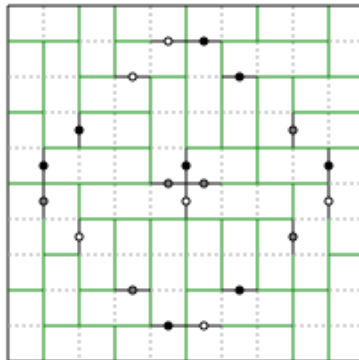

By dj Theme diamond

10 points

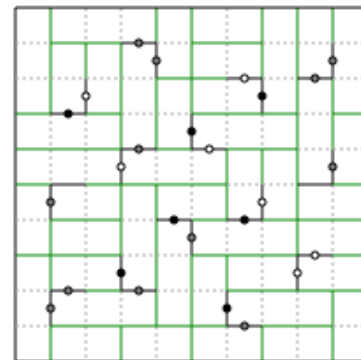

By dj Theme L shapes

Guide Arrow

3 points

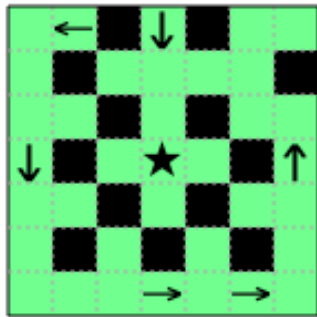

By dj Theme spiral

7 points

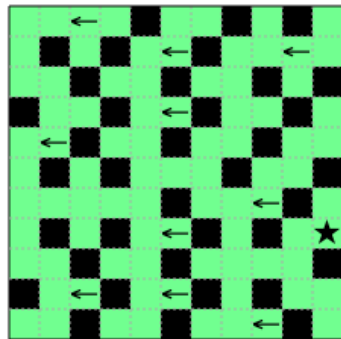

By ft Theme left

10 points

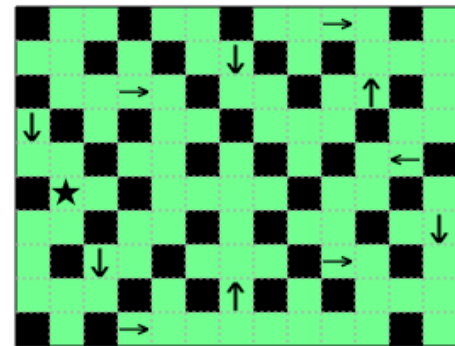

By dj Theme parallelogram

Star Battle

3 points

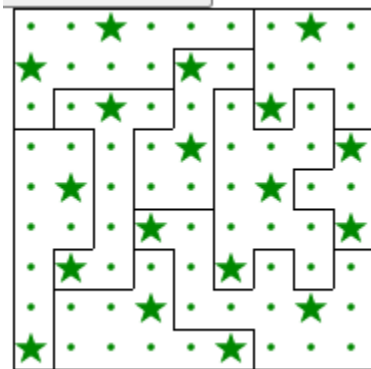

By dj Theme jk

6 points

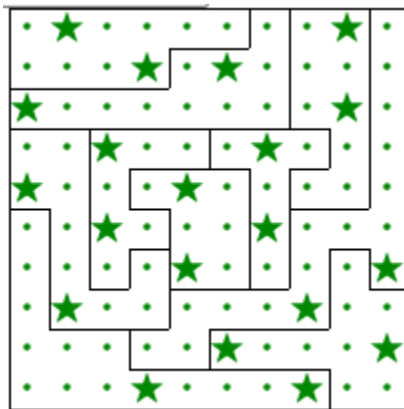

By dj, jk Theme ft

7 points

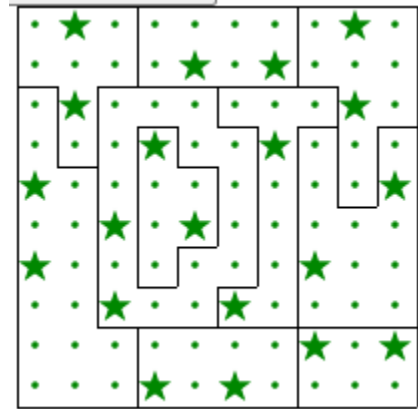

By ft Theme dj

Double Domino

3 points

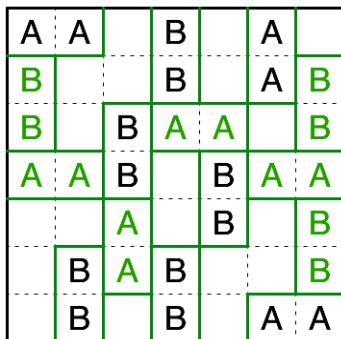

By dj Theme domino clues

5 points

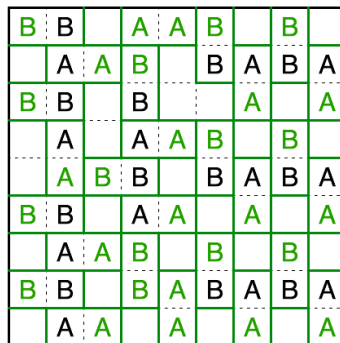

By jk Theme BABA

10 points

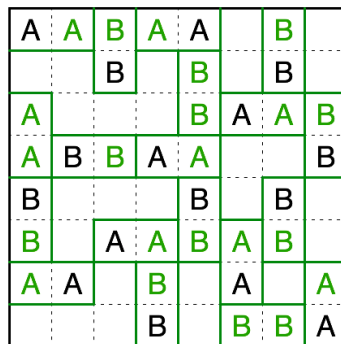

By dj Theme hiddens

Round 3: Powerhouses

Fillomino

3 points

4	4	4	1	4	4	5	5
4	1	2	4	4	5	4	5
1	4	2	5	5	5	4	5
4	4	3	3	5	4	4	5
5	4	3	5	3	3	3	2
5	2	2	5	4	4	4	2
5	5	1	5	4	2	2	4
5	1	5	5	1	4	4	4

By dj Theme battenbergs

5 points

3	3	1	3	3	3	4	3	3	1	6	6
1	3	2	2	4	4	4	1	3	2	2	6
2	2	3	3	3	1	2	2	1	3	3	6
3	3	4	4	2	2	1	3	3	4	3	6
4	3	4	1	3	3	3	4	3	4	1	6
4	1	4	2	2	4	4	4	1	4	2	2
4	2	2	3	3	3	1	2	2	4	3	3
4	3	3	4	4	2	2	1	3	3	4	3
1	4	3	4	1	3	3	3	4	3	4	2
4	4	1	4	2	2	4	4	4	1	4	2
1	4	2	2	3	3	3	1	2	2	4	1

By jk Theme 1234s

7 points

4	3	3	9	3	4	4	9	4	4
4	4	3	9	3	3	4	9	4	9
4	6	6	9	9	9	4	9	4	9
5	4	6	6	9	1	9	9	9	9
5	4	4	6	9	6	6	3	3	3
5	5	4	6	9	9	6	6	2	2
5	4	2	1	6	6	1	6	3	3
4	4	2	6	6	5	5	6	4	3
5	4	5	6	5	5	4	4	4	2
5	5	5	6	5	3	3	3	1	2

By dj Theme empty middle

Statue Park

3 points

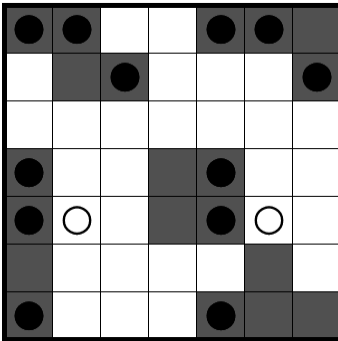

By dj Theme two halves

6 points

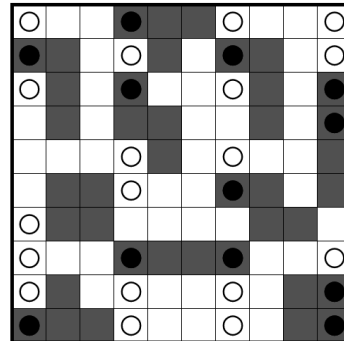

By dj Theme columns

8 points

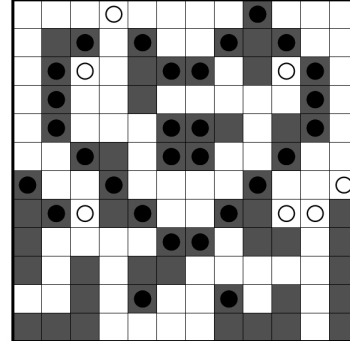

By ft Theme heart

Slitherlink

2 points

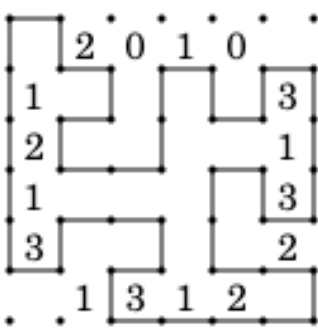

By dj Theme empty middle

4 points

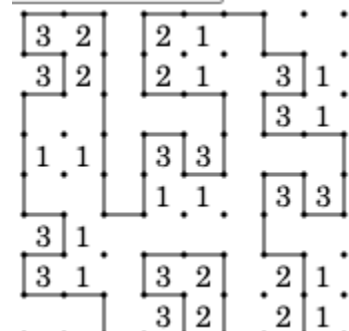

By dj Theme anti 2x2s

7 points

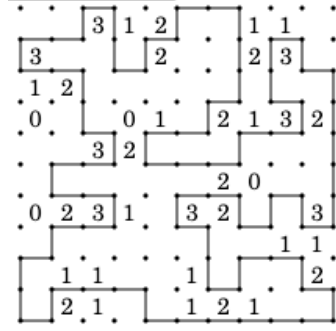

By dj, jk Theme tetrominoes



Round 4: Underrated Genres

Number Rope

3 points

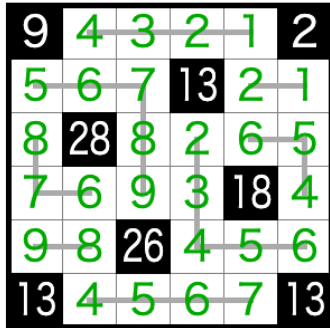

By dj Theme tilted square

5 points

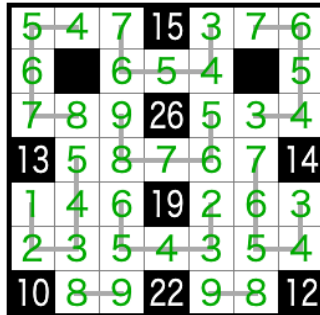

By dj Theme u turns

10 points

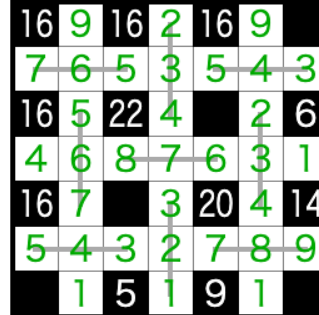

By jk Theme minimal arguments

Square Jam

2 points

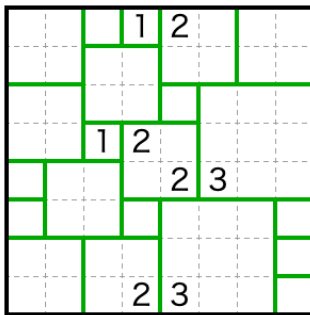

By dj Theme 12 23 pairs

5 points

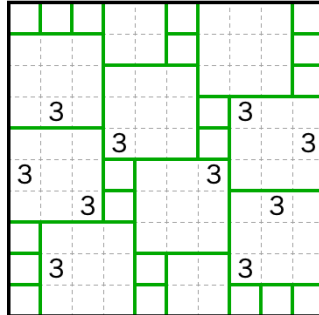

By jk Theme 3s

6 points

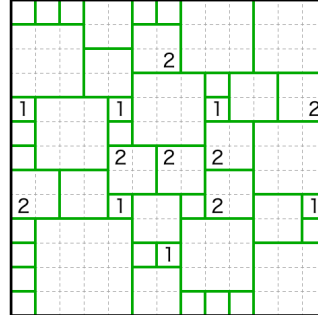

By ft Theme one two

Creek

3 points

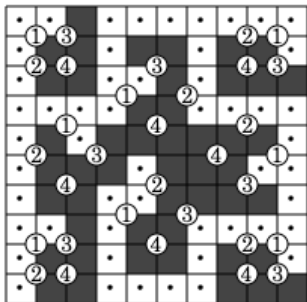

By jk Theme 1234

5 points

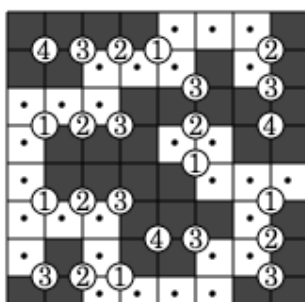

By dj, jk Theme consecutives

8 points

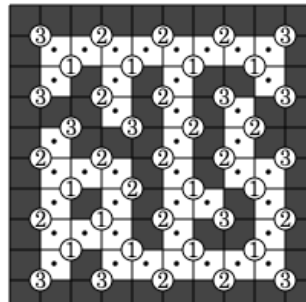

By jk Theme diagonals

Entry Exit

2 points

7 points

9 points

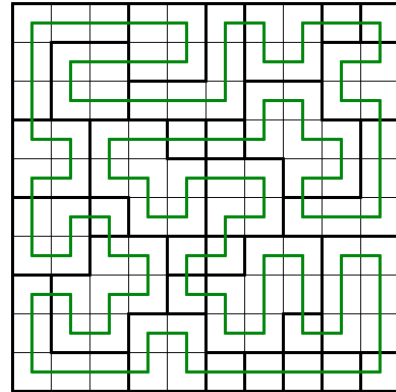
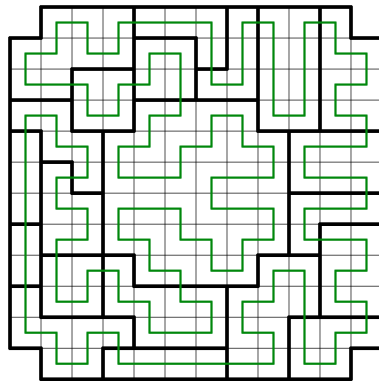
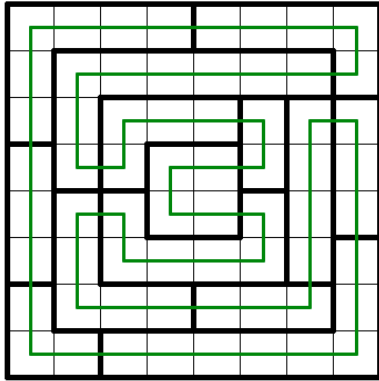

By dj Theme concentric

By dj Theme empty middle

By jk Theme heptominoes

Chocolate Banana

3 points

6 points

7 points

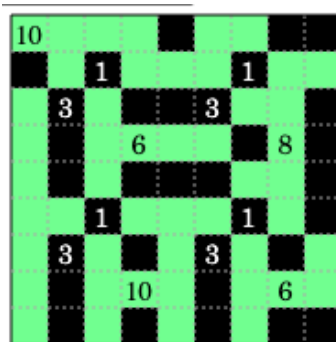
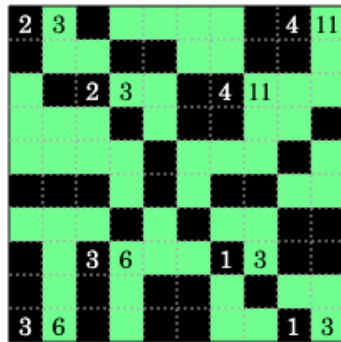

By dj Theme pairs

By dj Theme identical pairs

By jk Theme 13 diagonals

FourCells

3 points

7 points

9 points

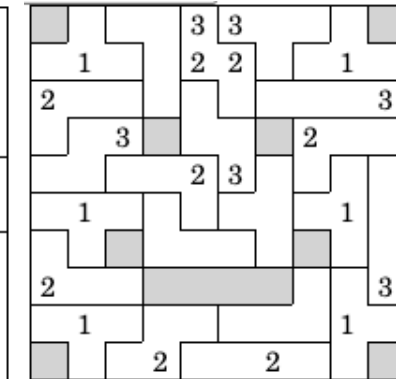
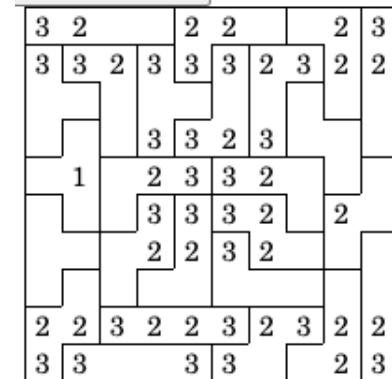
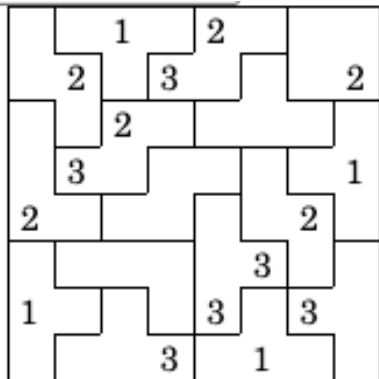

By dj Theme empty diagonal

By ft Theme full middle

By jk, ft Theme smile